

38" X 38" Center Drain Shower Pan

Specifications

- Model: Center Drain Pan
- Pan Size: 38" x 38"
- Finish: Textured - Non Slip
- Side Wall: 38"
- Back Wall: 38"
- Drain Location: Center - Drain Measures:
18-3/8" from Backwall
19-1/8" from Side Walls
- Drain Openings: 3 1/4"
- Front Curb: Integral 4 1/4" High
- Integral Flange on Sides and Back
- Weight: 105 lbs.
- Material: Cultured Marble
- Our Product Complies with one or more of the following: IAPMO, ANSI, CSA & ASTM F462-79 Coefficient of Friction Test; FHA/ANSI-B meets dimensional requirements of Fair Housing Act Design Manual



PICTURE NOT TO SPECIFICATION

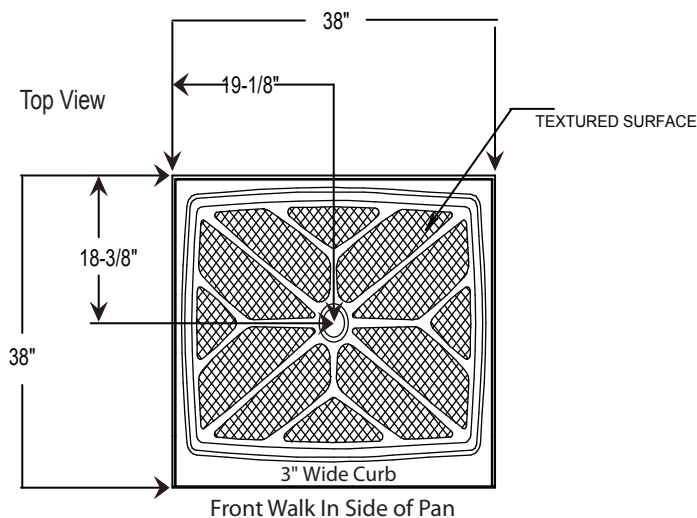

Standard Features

- Solid One Piece Construction
- Abrasion Resistant Gel Coat Surface
- Seamless
- Pre-leveled - Rest on Sub Floor
- Extremely Sanitary
- Water Proof and Leak Proof
- Bacteria Resistant
- Easy to Install
- Maintenance Free
- 10 Year Limited Warranty
- Made in the USA

Additional Accessory Options

- Shower Pan Protector

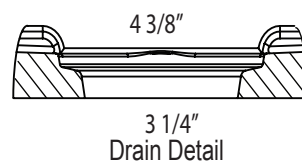
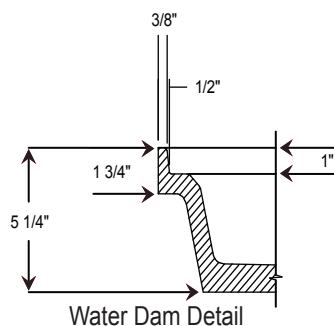

Please Note:
Drain is Not Included with Pan

To review color options for this product please contact your Sales Representative or refer to our website at:

www.mplcompany.net/request-color