



MPL
Shower Enclosures

SHOWER ENCLOSURES

MPL Company offers modern styling in a variety of shower designs utilizing our own glass hardware to produce a unique series of shower enclosures

BARN

Modern, minimal and simple design provides a clean and luxurious feel to a room where functionality is understated. Convenient when space is a premium, we provide two options and four finishes.

Newport
Monterey

BY-PASS

Innovative, custom quality engineering, delivering a beautiful appearance to any bathroom with space-saving needs. We have three design options and four finishes to choose from.

Santa Cruz
Pasadena
Fresno
Sonoma
Calistoga

SWING

We offer hinged and pivot options in our Swing shower collection. Made entirely of glass, our swing showers display an elegant and fresh aesthetic to your bath.

Malibu
Fremont
Industry

ACCLEAR

AC² Low Iron Hydrophobic Glass

Our AC² glass is available in Low iron, dual-sided hydrophobic coated that repels water and cleans easily.

Contact for availability.



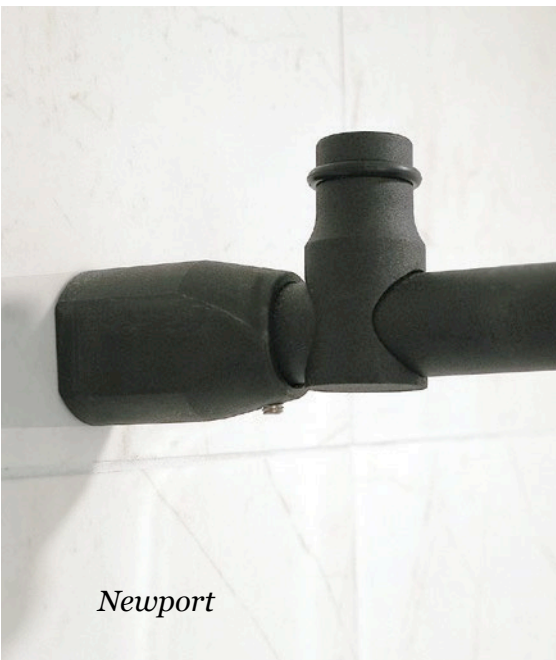

Newport Barn Door Shower

Our Newport sliding barn door is an adjustable, frameless shower enclosure accommodating up to 60" openings, with a 30" fixed panel on the shower head side. The dual slider trolley system smoothly glides along a 1" diameter rod designed to carry 10mm tempered glass door.

Newport



60" Barn Door Rod

Door Stop

U Channel



Newport Features

Dimensions 57" - 60" opening with 30" fixed panel, 76" OA height, 3/8" (10mm) glass

Pulls  ACM06312 (2)

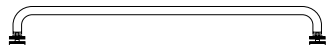
Towel Bar (optional)  ACR024

Hardware

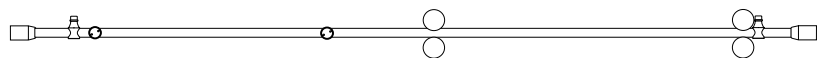

Finishes Satin Brass  Matte Black  Polished  Brushed 

Additional size options available
Standard fit range is 56"-60" opening



Monterey Barn Door Shower

Our Monterey sliding barn door is an adjustable shower enclosure accommodating up to 60" openings, with a 30" fixed panel on the shower head side. Custom widths and heights can be provided if desired.



Anti-Jump



Mounting Bracket



U-Channel



You can get any of our showers in Satin Brass

Monterey Features

Dimensions 60" track, 30" fixed panel, 76" OA height, 3/8" (10mm) glass

Pulls  ACHU6308 (2)

Towel Bar (optional)  ACHU24

Hardware

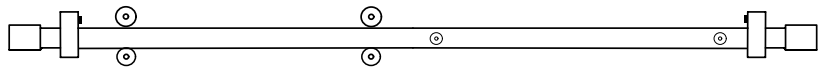

Finishes Satin Brass  Matte Black  Polished  Brushed 

Additional size options available
Standard fit range is 56"-60" opening



Santa Cruz



Santa Cruz By-pass Shower Door

Smooth gliding rollers and elegant lines frame this by-pass shower enclosure. Simple, space saving design creates a modern look and versatile shower operation.



AC099 Pull



Santa Cruz Features

Dimensions 60" top track mounted, 78" OA height with (8mm) glass

Pulls AC099 Flush pull

Towel Bar ACMT6318 Towel Bar

Hardware

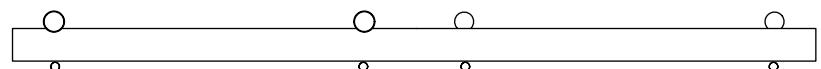

Finishes Satin Brass Matte Black Polished Brushed

Additional size options available
Standard fit range is 56"-60" opening



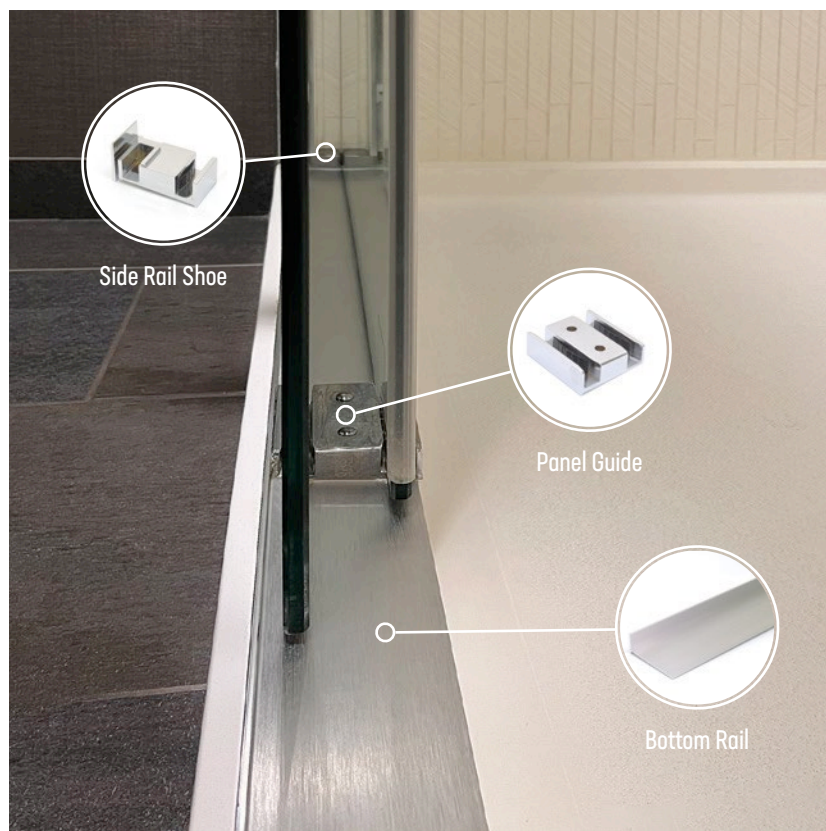
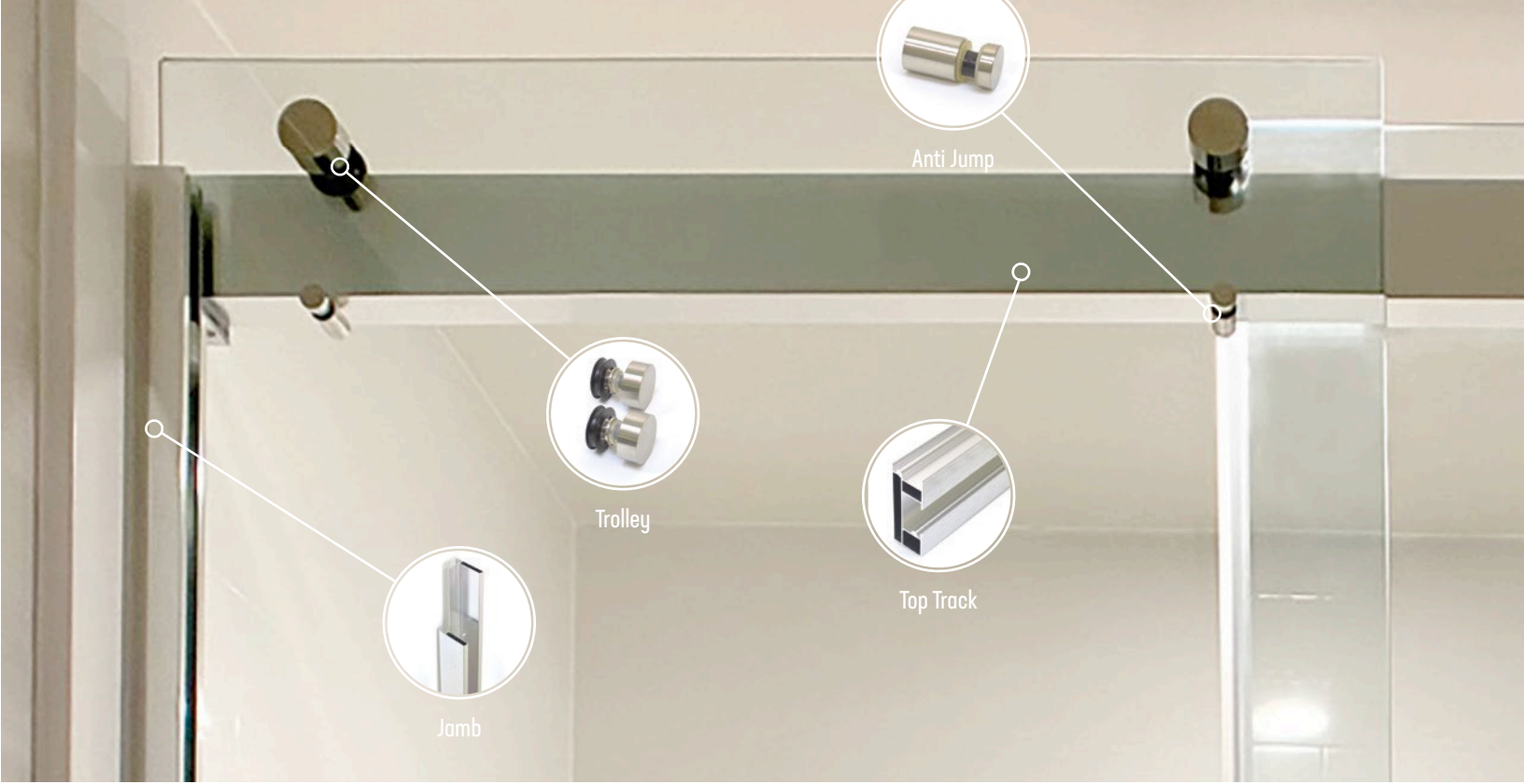

Pasadena By-pass Shower Door

The most popular system in our collection, our Pasadena by-pass has clean lines and modern appeal with minimal hardware that instantly makes the room feel larger and accessible.

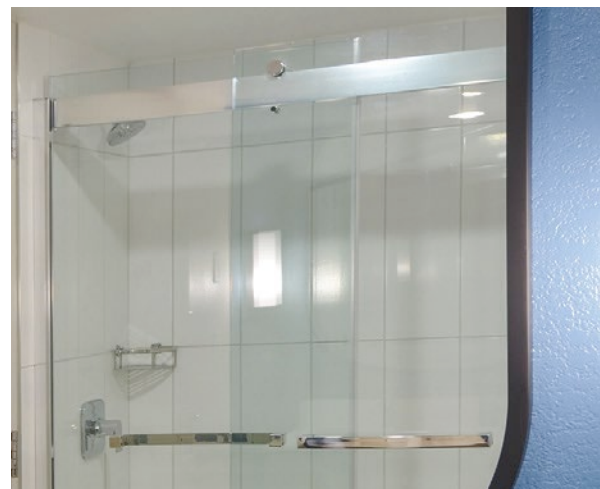
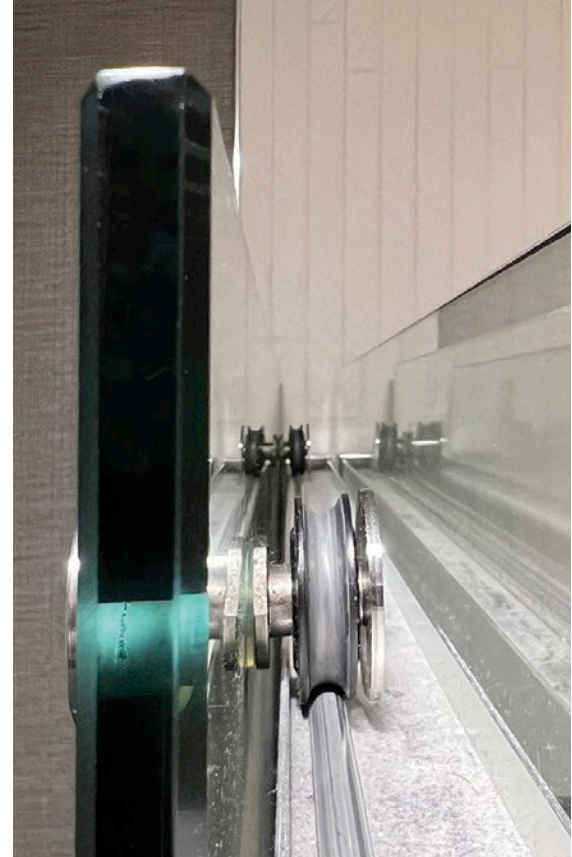

Pasadena Features

Dimensions 60" top track mounted, 78" OA height with (10mm) glass

Towel Bars  ACPA6316 (2)

Hardware

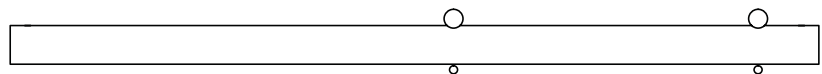

Finishes Satin Brass  Matte Black  Polished  Brushed 

Additional size options available
Standard fit range is 56"-60" opening

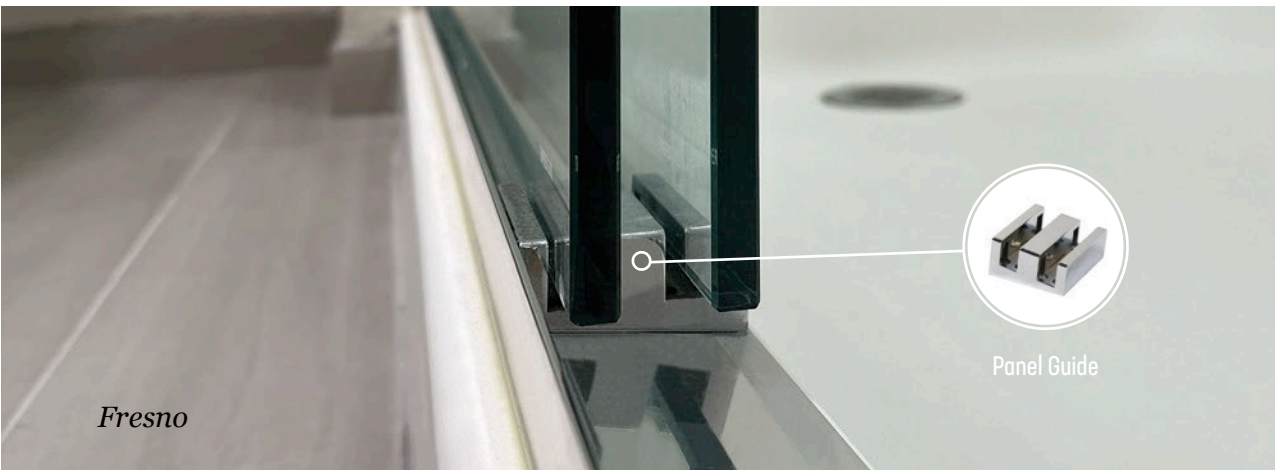
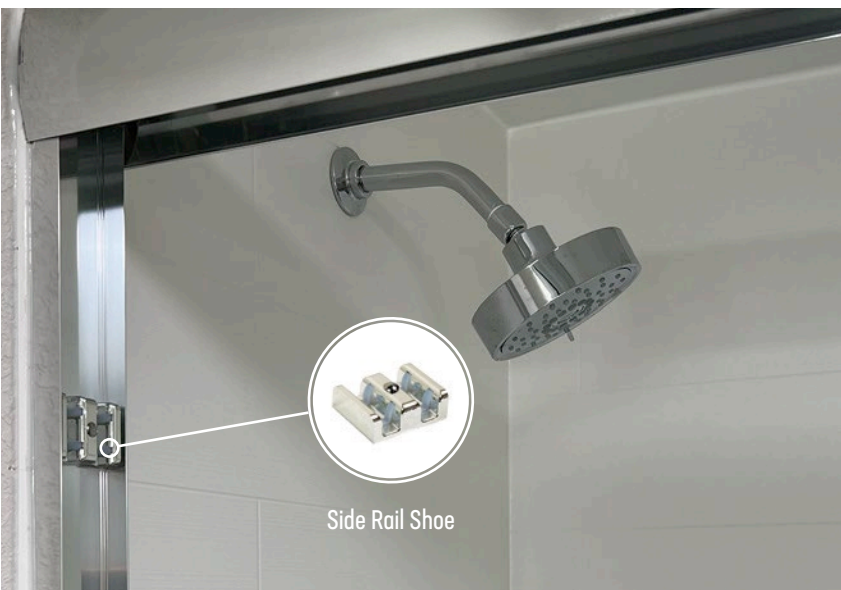
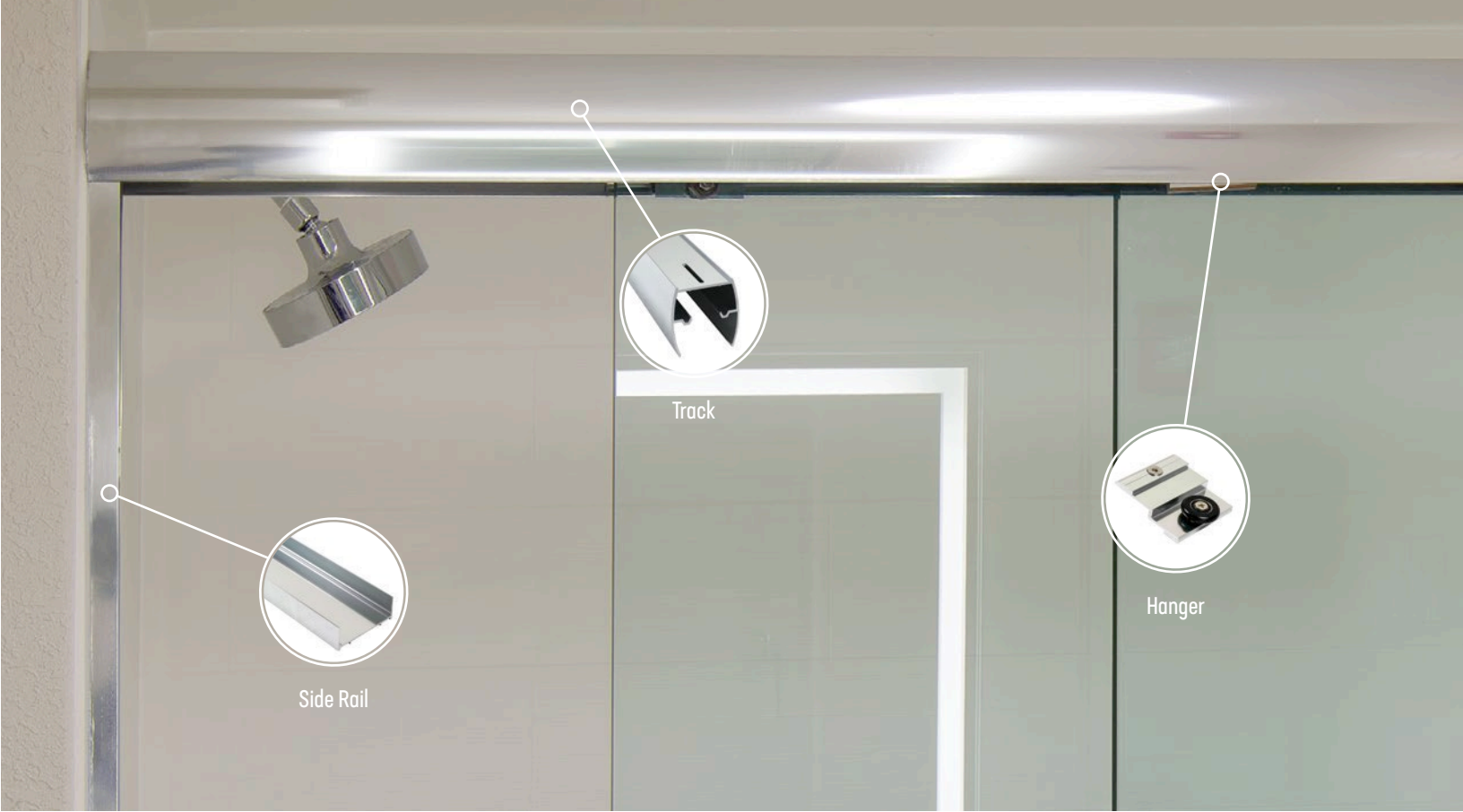

Fresno

Fresno By-pass Shower Door

A classic by-pass system with concealed hangers offering a softer feel with two tubular towel bars and bowed track.

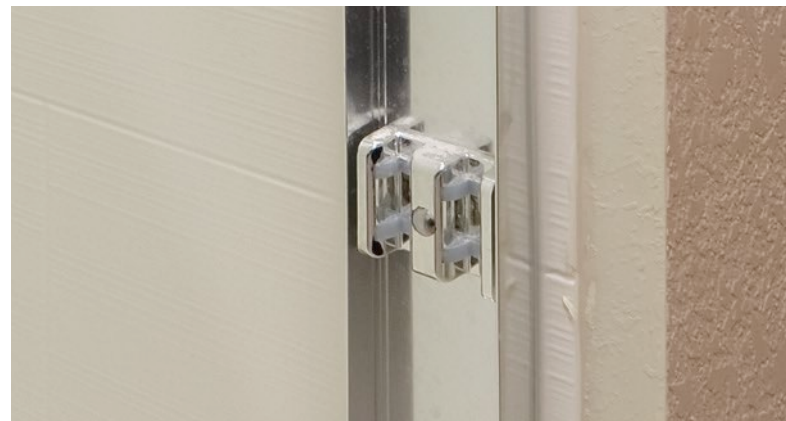

Fresno Features

Dimensions

60" top track, 78" OA height with (10mm) glass

Towel Bars

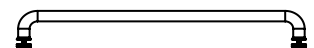
 ACRO24 (2)

Hardware



Finishes

Satin Brass  Matte Black  Polished  Brushed 

Additional size options available
Standard fit range is 56"-60" opening

Calistoga By-pass Shower Door

Fully framed by-pass shower utilizing 1/4"
(6mm) glass to fit on a 2" shower curb.

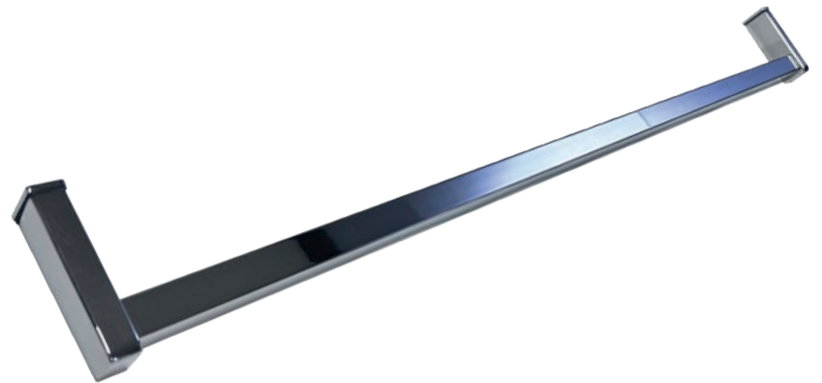
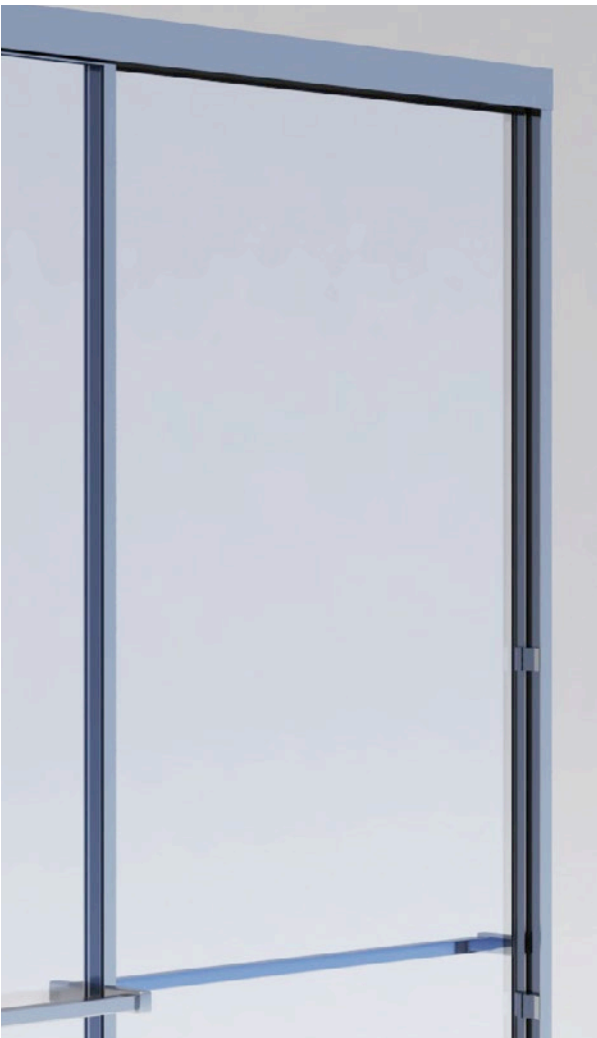

Calistoga Features

Dimensions 78" OA height fits standard opening range of 54" - 60", 1/4" (6mm) glass

Towel Bar

Hardware



Finishes

Satin Brass  Matte Black  Polished  Brushed 

Additional size options available
Standard fit range is 56"-60" opening

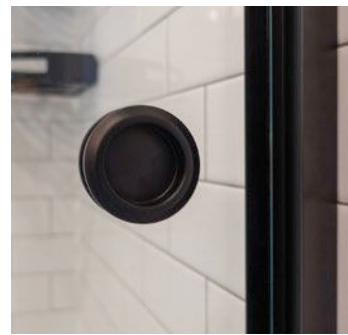

Sonoma By-pass Shower Door

Similar to our Santa Cruz, utilizing 1/4" (6mm) glass to fit on a 2" shower curb.

Sonoma Features

Dimensions 78" OA height fits standard opening range of 54" - 60", 1/4" (6mm) glass

Pull AC099 Flush pull

Towel Bar

Hardware

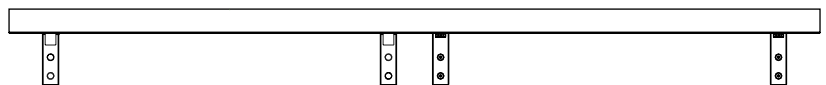

Finishes Satin Brass ● Matte Black ● Polished ● Brushed ●

Additional size options available
Standard fit range is 56" -60" opening

Calistoga By-pass Shower Door

Fully framed by-pass shower utilizing 1/4"
(6mm) glass to fit on a 2" shower curb.

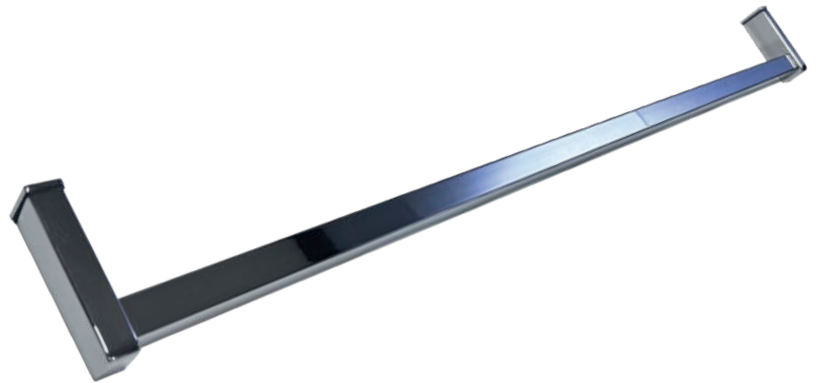
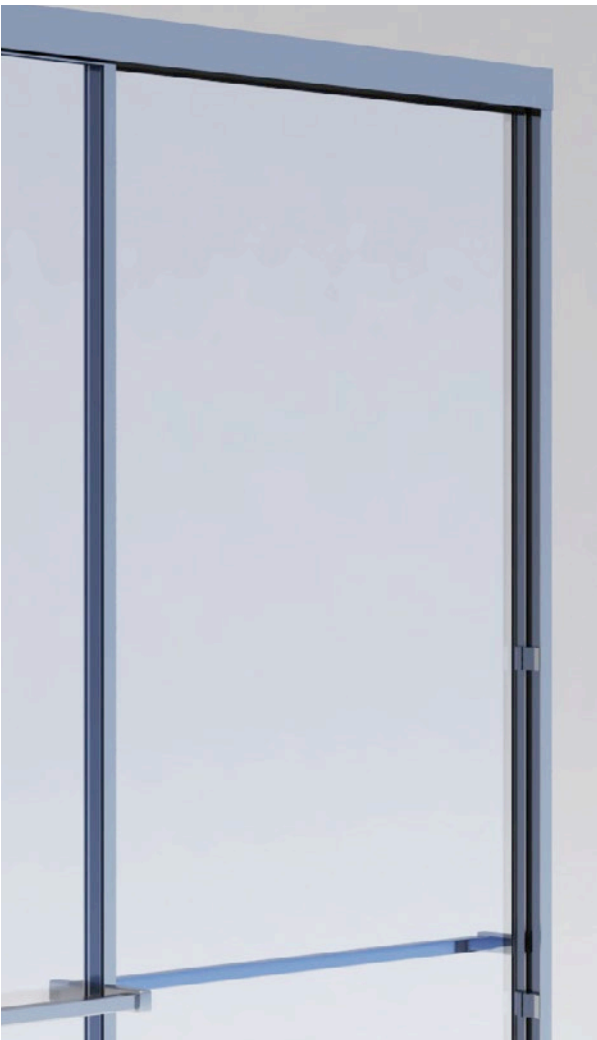

Calistoga Features

Dimensions 78" OA height fits standard opening range of 54" - 60", 1/4" (6mm) glass

Towel Bar

Hardware



Finishes

Satin Brass  Matte Black  Polished  Brushed 

Additional size options available
Standard fit range is 56" - 60" opening



Sonoma By-pass Shower Door

Similar to our Santa Cruz, utilizing 1/4" (6mm) glass to fit on a 2" shower curb.

Sonoma Features

Dimensions 78" OA height fits standard opening range of 54" - 60", 1/4" (6mm) glass

Pull AC099 Flush pull

Towel Bar

Hardware

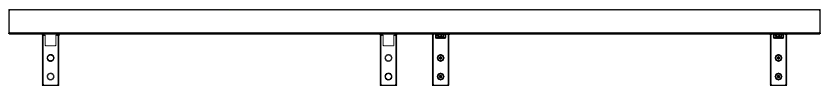

Finishes Satin Brass ● Matte Black ● Polished ● Brushed ●

Additional size options available
Standard fit range is 56"-60" opening



Malibu

Malibu Custom Swing Shower

3/8" Swing Door Glass Shower Enclosures with multiple options.

Glass-to-wall hinge

Glass-to-wall hinge with fixed panel at strike side

Glass-to-glass

Glass-to-wall hinge with fixed panel

Glass-to-hinge with fixed panel at strike side

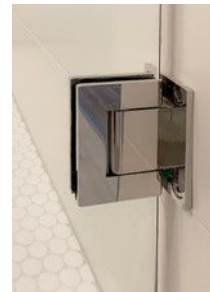
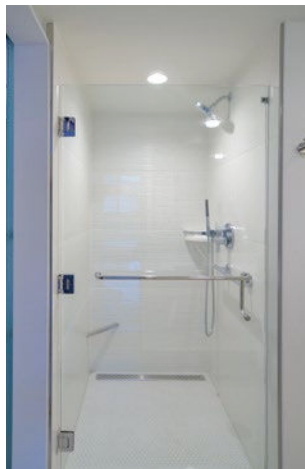

Malibu Features

Dimensions 76" OA height with 3/8" (10mm) glass in 4 options

Pulls ACHU8X8, ACHU8X18, ACM06312, ACR08X8, ACR08X18

Hardware (Hinges) ACSD-H90, ACSD-HD90, ACSD-H180, ACSD-HD180, ACUC, ACUC3438, ACSDVS990, ACSDS990

Finishes Satin Brass Matte Black Polished Brushed

Fremont Metal Frame Swing Shower Door

5/16" (8mm) fixed panel and 3/8" (10mm) Swing Door Glass Shower Enclosure with Multiple Options.

Pivot Hinge

Pivot Hinge with Fixed Panel at Strike Side

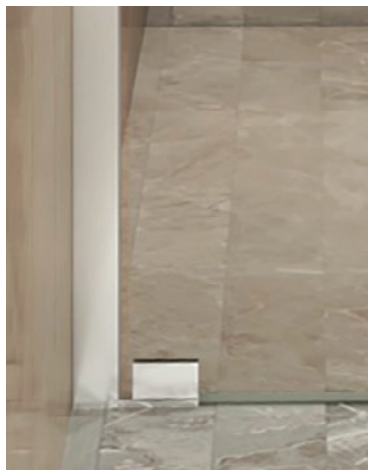

Available Finishes for our Metal Showers

Satin Brass  Matte Black  Polished  Brushed 

Industry Metal Frame Swing Shower Door



MPL SHOWER ENCLOSURES

Barn Door Shower

NEWPORT

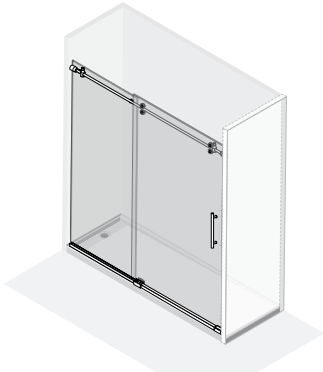

57" - 60" opening with 30" fixed panel, 76" OA height, 3/8" (10mm) glass

MONTEREY

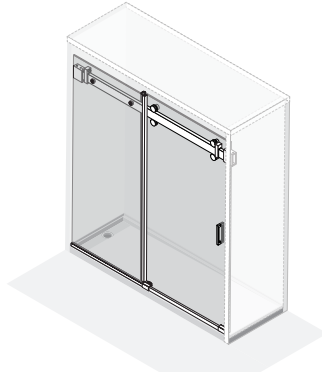

60" track, 30" fixed panel, 76" OA height, 3/8" (10mm) glass

Bypass Shower

SANTA CRUZ



60" top track mounted to 78" tall side rails, 5/16" (8mm) glass

PASADENA



78" OA height fits standard opening range of 54" - 60", 3/8" (10mm) glass

FRESNO



78" OA height fits standard opening range of 54" - 60", 3/8" (10mm) glass

SONOMA



78" height fits standard opening range of 54" - 60", 1/4" (6mm) glass

Bypass Shower

CALISTOGA

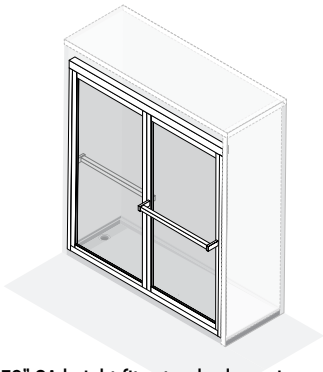

78" OA height fits standard opening range of 54" - 60", 1/4" (6mm) glass

Swing Shower

MALIBU

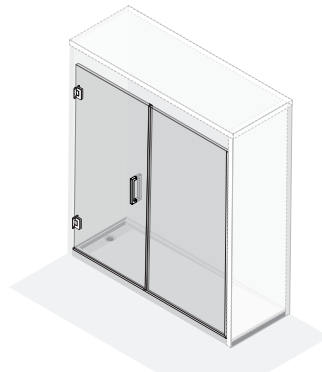

76" OA height, swing door, 3/8" (10mm) glass

FREMONT

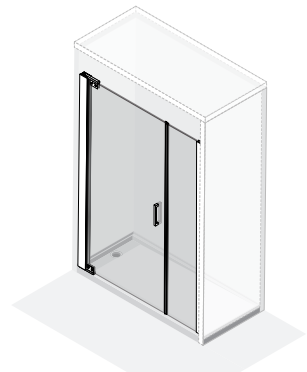

76" OA height, pivot door, 5/16" fixed panel and 3/8" (10mm) glass door



Customize Your Shower Door & Enclosure With Modern Styling

We champion modern styling in a variety of shower designs utilizing our own glass hardware to produce a unique series of shower enclosures.



Connect with one of our shower system experts

1 (800) 466-7465



Explore More of our innovative shower products and solutions

MPLCompany.net

MPL  **Company**

Commercial Bath Solutions